

**PICANOL**  
Let's grow together



# TerryPlus-i Connect



Make this  
brochure  
**come alive.**

Download the Picanol app.



SCAN HERE  
FOR THE APP

ENGLISH

His **eagerness to grow** is our benchmark.



## The future. Should we be afraid of it?

At Picanol we believe our children already show us what the future brings. Their expectations are **our new benchmarks**.

His **openness to novelty** is our benchmark

Their **care for the planet** is our benchmark

Her **lack of patience** is our benchmark

Her **ease with technology** is our benchmark

**Their today is our tomorrow.**

Because more than ever, in the future, we don't just want to grow. We want to **grow together**.



SCAN HERE FOR THE APP

Discover our vision in a video by scanning the image above with our new app.

[www.picanol.app](http://www.picanol.app)

**PICANOL**   
Let's grow together

# Our design principles: how we build our machines.

When starting the design of a new machine, we have to do better than just a few picks faster than the previous generation. Today's world is all about connectivity, user-centric design, intuitive controls, self-learning capacities and sustainability ... to name just a few.

**These are the benchmarks for a future-proof design.**



## Smart Performance

Performance is the first requirement for any machine or feature, and the obvious indicator is the **theoretical maximum speed**. Very often, however, the gap between this theoretical speed and **the effective speed** under real-life conditions is huge.



## Sustainability Inside

When it comes to **preventing waste** and **reducing energy consumption**, Picanol has long faced up to its responsibility. Our machines are designed with a built-in capacity for sustainability.



## Driven by Data

We all know that **digitization** will become ever more important in the next decades. **Data** have to be captured and made available for **artificial intelligence**, making production more efficient.



## Intuitive Control

Kids nowadays handle new technology **effortlessly and intuitively**. That's what we want for our machines as well. Just like your smartphone or your car, the **machine display** is the interface that controls nearly all the machine functions.

**Smart Performance, Sustainability Inside, Driven by Data and Intuitive Control** are the basic principles of any Picanol weaving machine. They allow your company to thrive in today's world of Industry 4.0: connected, digital and sustainable.

That's why we at Picanol design our machines around the principle of 'Smart Performance': **intelligent machine design** combined with self-setting software, allowing the highest possible practical speed and best performance under all conditions.

We have demonstrated this with our pioneering Sumo drive. Introduced back in 1996, it is still the **most energy-efficient** main drive available. Sustainability is also about **waste management**. We not only reduce waste but also try to avoid it completely.

Ever since the first introduction of electronics on weaving machines in the 1970s, Picanol has been at the **forefront of digitization**. With every new machine, we continue to be a trendsetter in this field and to further deploy Industry 4.0 in the weaving industry: the **self-setting machine** is just around the corner!

Wireless-ready, robust and **designed for instant readability**: new generations will not accept anything less! This **user-centric approach** is also embedded in the design of the overall machine, making all operations easy, intuitive and self-explanatory.

# TerryPlus-i Connect

## The new benchmark in airjet terry weaving

Building further on nearly 40 years of experience in airjet weaving and over 100,000 airjet machines shipped, the new TerryPlus-i Connect combines this rich heritage with a clear vision of the future.

At Picanol, we believe that in this fast-changing world of weaving, the needs of weaving mills in general and the expectations of our customers and their operators are evolving rapidly. Our market is nowadays driven by an increasing concern for environmental topics, higher costs, and the lower availability of resources and skills, as well as the digital revolution.

That is why the TerryPlus-i Connect – which is based on the OmniPlus-i Connect – has been built around our **four leading design principles**.

### Smart Performance

Picanol machines have always been built for maximum performance, and they always will be. **Smart performance** focuses on ensuring the highest industrial speeds in the market in combination with top quality.

With the TerryPlus-i Connect, the insertion time is optimized with the **new generation of sley cams**, while the rigid yet extremely light construction of the **pneumatic pile backrest** guarantees perfect loop formation for even the most complicated terry designs.

### Sustainability Inside

The further reduction of energy consumption is not an optional extra – it has to be embedded in the machine design. With its **modified relay nozzle distance**, the new TerryPlus-i Connect offers more **stable insertion** and consequently new possibilities for achieving a **further reduction in energy consumption**, even by automated algorithms. In other words, **sustainability is inside**.

### Driven by Data

Picanol has pioneered the digitization of weaving machines for many decades now. **SmartShed** – the fully electronically controlled shedding motion incorporated in the new TerryPlus-i Connect – is a logical next step in this evolution. This together with an abundant **use of sensors** generates lots of data that fuel real-time optimization algorithms and promise even more gains in productivity when combined with other data. And this even applies to data from other machines. Therefore, weaving with Picanol becomes truly **driven by data**.

### Intuitive Control

Picanol machines are always designed to be as user-friendly as possible. Thanks to the **BlueTouch display** with its complete newly designed user interface, the **Smart signal lights** and the implementation of Access control, the highest level of **intuitive control** has been incorporated in the machine design of the TerryPlus-i Connect.

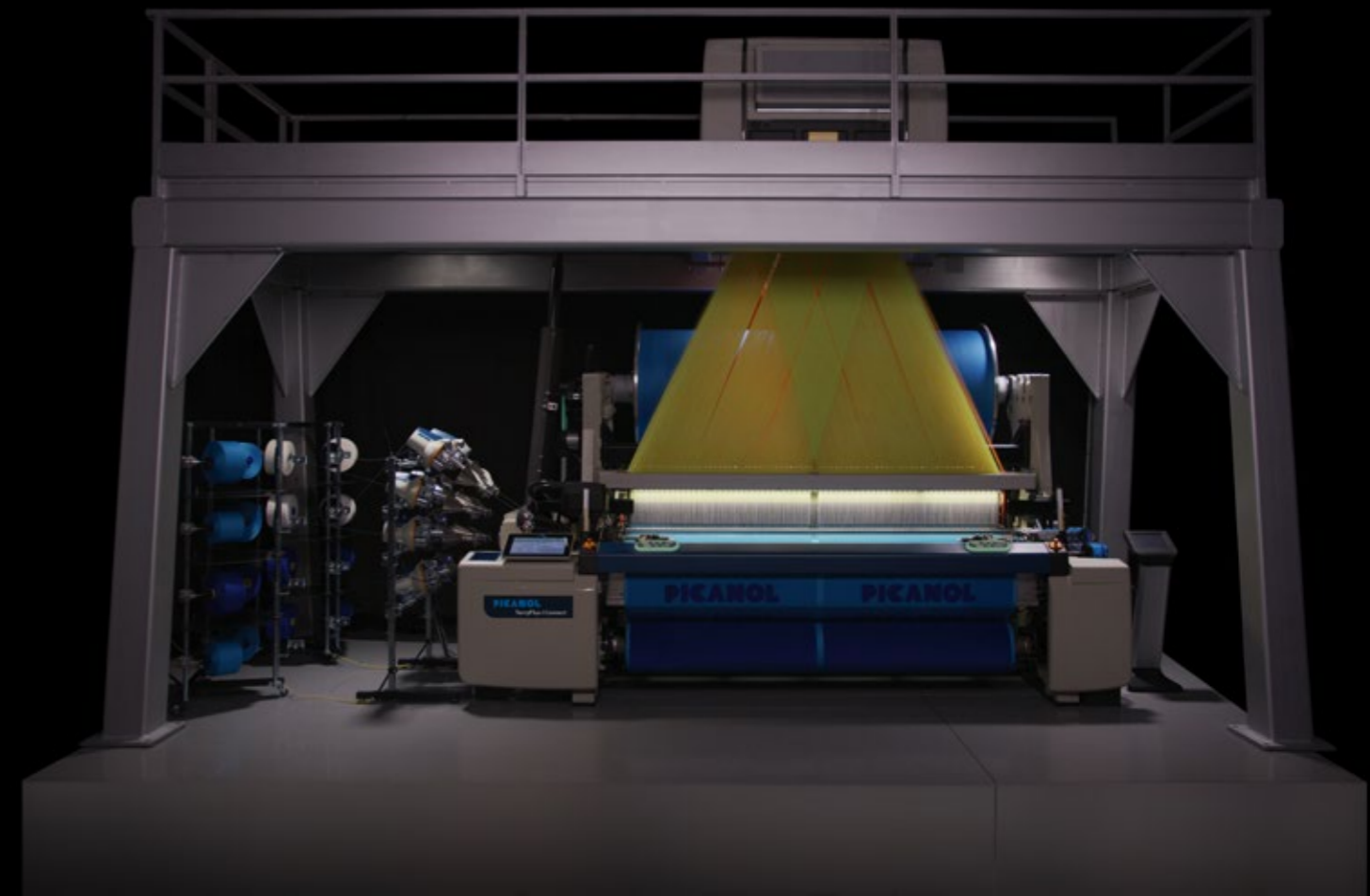

### Now enabled by PicConnect

PicConnect is our online platform offering digital services. It serves as a powerful extension of your weaving capabilities. Whatever your reflexes tell you to do, PicConnect amplifies it. We call it intuitive weaving – it's about allowing you to follow your weaving instincts. Learn more at [www.picanol.be/intuitiveweaving](http://www.picanol.be/intuitiveweaving)



Scan the pictures of the features in this brochure with the Picanol app and learn more about their possibilities.



## Stable pile formation, even at the highest speeds

Thanks to the unique **pile motor set-up** directly driving the cloth and backrest movement simultaneously, **accurate pile formation** is assured at highest speeds.



## Optimum loop formation regardless of fabric design

The rigid yet extremely light construction ensures a highly dynamic behaviour, **guaranteeing perfect loop formation** for the most complicated terry designs, be it very light towels or heavy bathmats. This is by far the best pile compensation system ever!

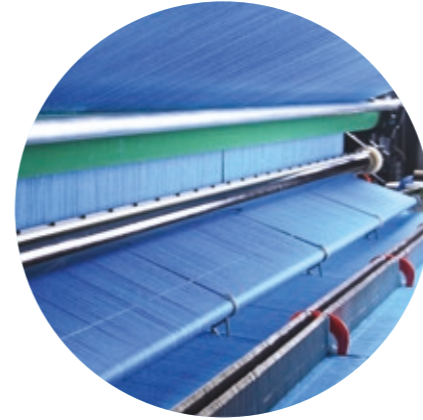

## Smart Performance

## Set each weft channel individually for optimum insertion

**Large separate air tanks** built into the machine sideframe, enable optimum setting by means of an electronic pressure regulator for each individual weaving channel.

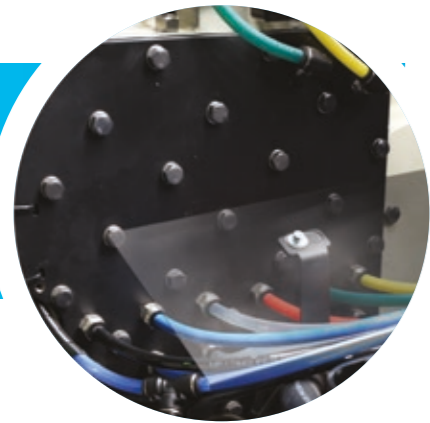

## Maximize industrial speeds

The **new-generation sley cams** are designed and produced by Picanol. The optimized reed motion is invaluable for coping with unclear sheds, affording more insertion time at even higher speeds.



## Solid structure, the basis for any application

The proven Picanol concept combines **two solid sideframes** connected by **large-section cross rails**. The sley is driven from both sides by conjugated cams.



## A full range of high-performance shedding motions

The new Picanol independent and motorized shedding motion, **SmartShed**, is available. In addition the **full range of shedding motions** is also possible, including the independently driven jacquard.



## For every style, the desired filling length immediately

The unique, patented design of the **Blue22** and **Blue11** prewinders allows quick and easy setting of the weft length. With the **EasySet** function, set-up is fully electronic, drastically reducing the time needed for style change.



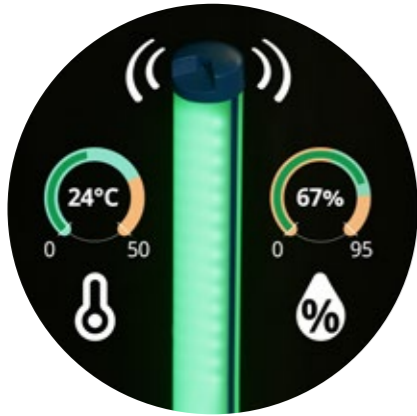

### No more doubts about the temperature and humidity

Every Picanol machine has an **integrated temperature and humidity sensor**. The data is available on the BlueTouch display.

### Manage the filling length to reduce waste

The unique, patented design of the **Blue22 and Blue11 prewinders** makes adjustment of the waste as quick and simple as possible. And with the **EasySet function** it is even fully electronic.



### The stability needed to optimize air consumption

With the optimized **relay nozzle spacing** the stability of the weft insertion is lifted to a higher level. This makes it possible to minimize air consumption without compromising on fabric quality and machine stop level.

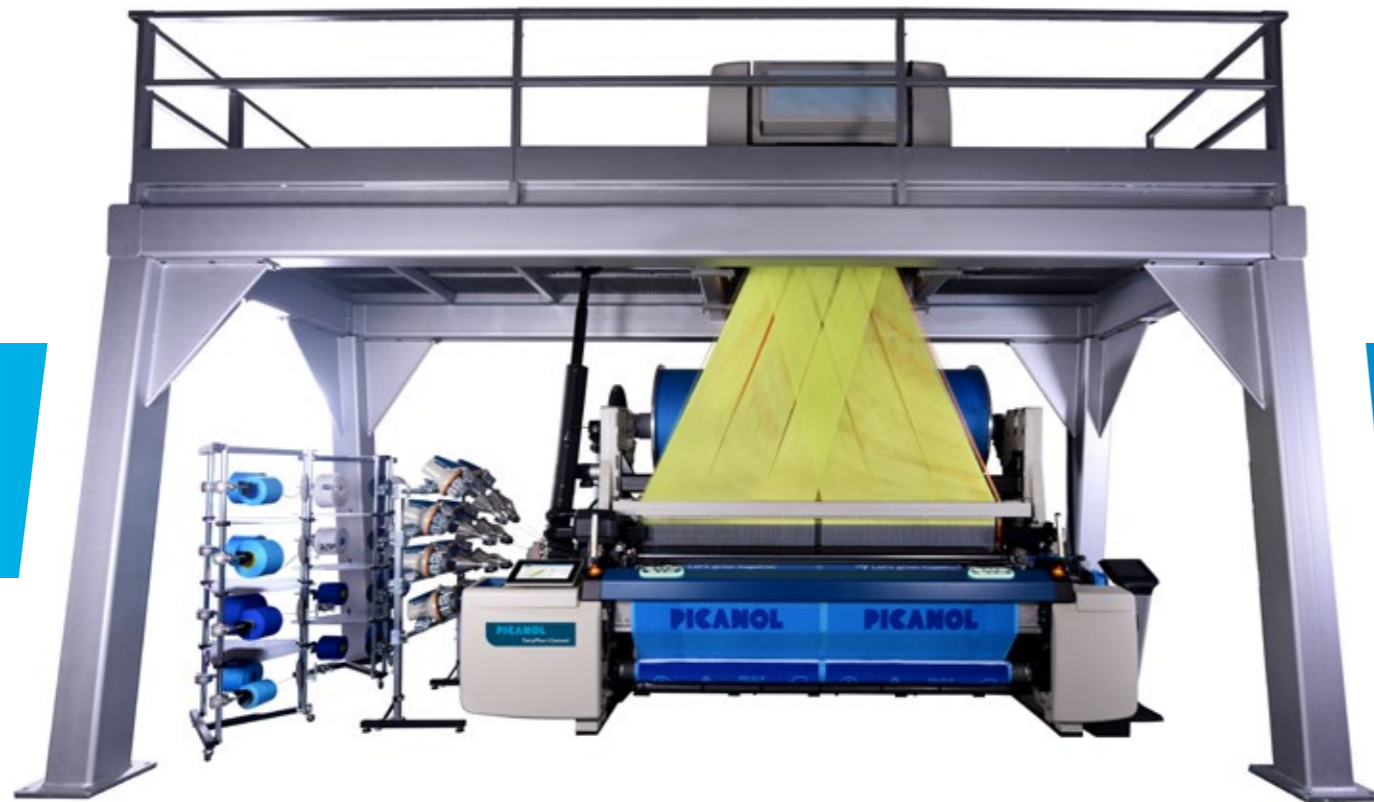

## Sustainability Inside

### Full sustainability inside

The perfect set of tools to **minimize the energy consumption**: Power monitoring, AirMaster, and ARVD II Plus.



### The most energy-efficient main drive has now become even more energy-efficient

The redesigned **SUMO** drive concept pioneered by Picanol is the most energy-efficient main drive on the market. It affords the **lowest possible energy consumption** while at the same time offering many other advantages such as full-range speed control, slow motion, pick finding, and even **automatic crossing setting**. The new integrated temperature sensor completes the redesign.



## No design limitations

The **pile height-changing** device makes it possible not only to change the group beat-up rate but also **to weave structures** such as waves. All set on the display!



## The highest level of digitization

The **15.6" BlueTouch display** is the perfect tool for both handling and visualizing your data. This is clearly illustrated with examples such as the **Sensor dashboard** and the action center with **Logbook** functionality.



## The reliable electronic platform, ready for Industry 4.0

The **BlueBox electronic platform** got an update to enable **improved data handling**. In combination with the well-known reliability and the new design of the BlueBox, this sets the benchmark for electronic platforms in the market.



## Prepare your weaving mill for the next industrial revolution

**PicConnect** is the gateway to all of **Picanol's digital services**, from industrial IoT to service-related applications. PicConnect enabled means that the machine is ready to fully leverage PicConnect applications.



## Perfect overview of sensor data

Essential sensor data is **easily accessible** and can be visualized on a dedicated dashboard on the **BlueTouch display**.

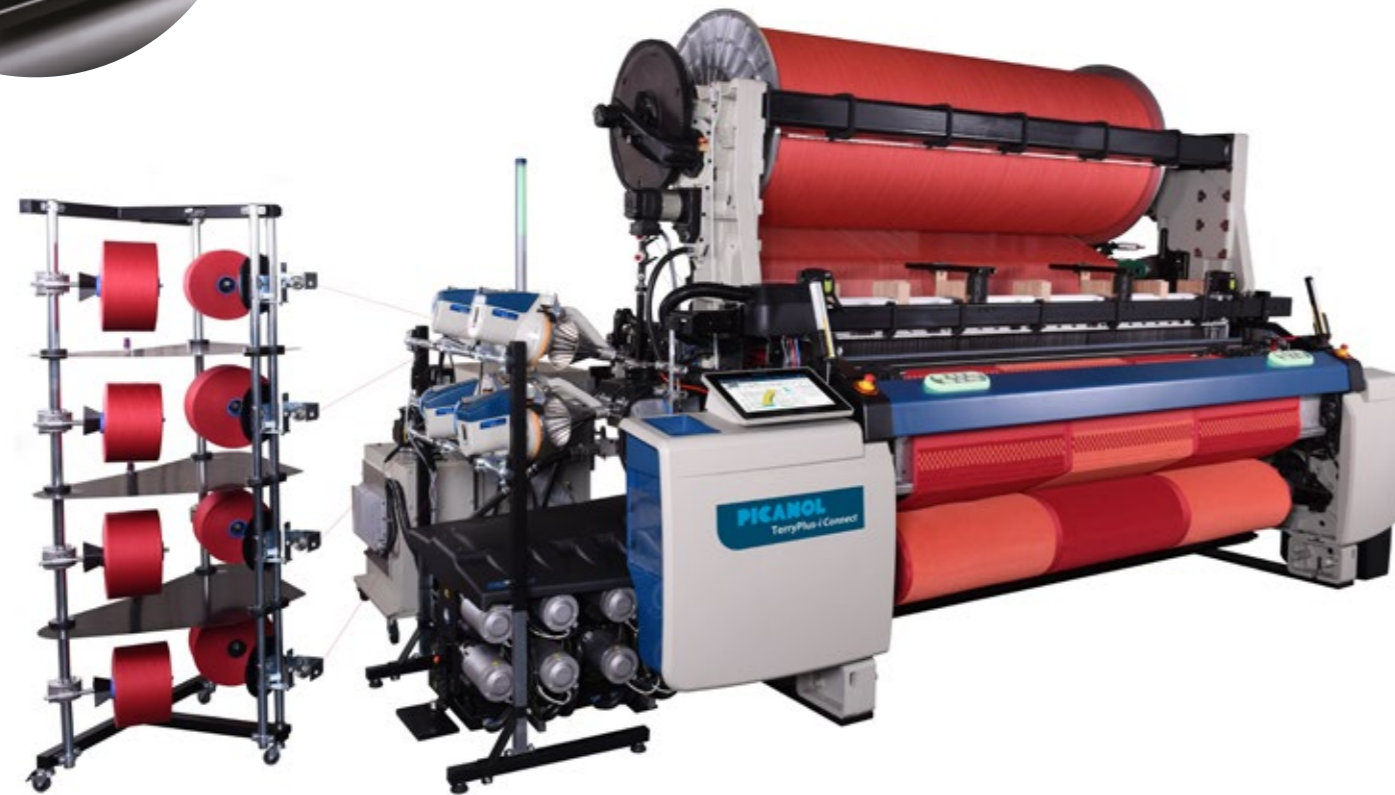

## Driven by Data

## The smart digital shedding motion

**SmartShed** is built for weavers who want **maximum digitization and flexibility** in the weaving process. The movement and crossing timing for each harness frame are now electronic settings. In addition the harness frame stroke is measured electronically and shown on the machine display.



## Let the machine be smart

Various sensors continuously feed data into algorithms so as to optimize the performance of the machine. **ARVD II Plus**, for example, reduces air consumption automatically, while **PRA II Plus** is the fastest and most reliable automatic pick repair system on the market. The Picanol **AirMaster** allows measurement of air consumption as well as detection of leakage and blockage.

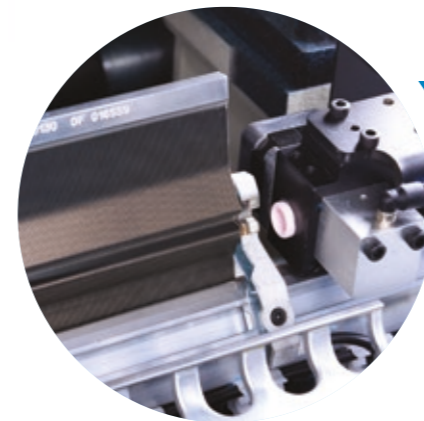

## Full and quick data control at your finger tips

The advanced **15.6" BlueTouch display** allows **quick access** and **control of all settings**. With features such as **Access control**, help functionality, and others, the BlueTouch display sets new standards in the market.



## Smart visibility of the machine status

The light combination of the **LED signal torch** and the LED strip on the **push buttons** is **synchronized**. In addition, it can be fully customized by the user.



## Fully digital air pressure settings

Unique! The user can adjust all **pressure settings** and transfer them to other machines quickly and easily. Full **digitization** also makes other automated functions possible, such as **AirMaster** self-diagnosis.



## Enjoy operating the machine

In addition to the various **user-friendly features** that are standard on all Picanol machines, handling the machine is made even easier thanks to a range of **innovative design features**.

## On Picanol machines only! All shed information is available at the snap of your fingers

The **settings of the shed** can now be done in the most intuitive way thanks to the **visualization** of the shed on the BlueTouch display.



## Full control of your machine settings

**Access control** manages the access level of the different users and allows you to define personal screens.



## Intuitive Control



# TerryPlus-i Connect

## Technical specifications

\* patented  
\*\* patent pending

### Fabric specifications

Useful widths	230, 260, 280, 340 and 360 cm		
Width reduction	Up to 96 cm depending on reed width (asymmetrical)		
Yarn range	Spun yarns	Nm 170 - Nm 4	Ne 100 - Ne 2.4
	Filament yarns	20 den - 1,000 den	22 dtex - 1,100 dtex

Standard Optional Aftermarket

### Connect packages

	Standard	Optional	Aftermarket
Monitor package	-	●	●
Access control	-	-	-
OptiStyle	-	-	-
Raw material use	-	-	-
Smart savings package	-	●	●
Power monitoring	-	-	-
AirMaster with integrated air consumption meter *	-	-	-
ARVD II Plus - Adaptive Relay Valve Drive *	-	-	-
Automation package	-	●	●
PRA II Plus - Pick Repair Automation *	-	●	●
PSO - Prewinder Switch-Off	-	●	●
Harness frame stroke measurement & Shed simulation (SmartShed or doobby)	-	●	●

### Pile formation

	Standard	Optional	Aftermarket
Direct driven cloth formation for up to 12 mm pile height	●	-	-
Pile height monitoring	-	●	●

### Weft insertion

	Standard	Optional	Aftermarket
Weft selection	Up to 8 colors	●	-
	Double pick insertion	-	●
Prewinders & options	Adjacent windings	●	-
	Blue22 *	●	-
	Blue22 EasySet *	-	●
	Separated windings	-	●
	Blue11 EasySet *	-	●
	Integrated bobbin break sensor	●	-
	Yarn store sensor	●	-
Winding sensor	●	-	
PSO - Prewinder Switch-Off	-	●/package	●/package
Weft brakes	Balloon breakers	●	-
	PFT - Programmable Filling Tensioner	●	-
Weft cutter	Electronic weft cutter with separate cutting time per color	●	-
Main nozzles	Fixed and movable main nozzles *	●	-
	Clamp on movable main nozzles	-	●
	PosiJet *	-	●
	ELCA - Electronic Low Continuous Airflow *	●	-
Relay nozzles	Multi-hole relay nozzles	●	-
	Optical weft detector in front or next to the reed	●	-
	Second weft detector in front or next to the reed	●	-
Weft detector	Argus weft detector	-	●
	Stretch device	Twin stretch nozzle *	●
	Weft extractor with waste ribbon guidance	-	●

Standard Optional Aftermarket

Automation and software tools	AIC - Adaptive Insertion Control	-	●	●
	PRA II Plus - Pick Repair Automation *	-	●/package	●/package

### Warp let-off

Let-off system	ELO - Electronically controlled Let-Off	●	-	●
Warp beam	Ground diameter 805 mm - 1,000 mm	●	-	●
	Pile diameter 805 mm - 1,000 mm - 1,100 mm - 1,250 mm	●	-	●
Backrest	Double backrest rollers	●	-	●
	TSF - warp tension sensor in the feeler	●	-	●
	Pneumatic pile backrest with TCLS -	●	-	●
	- pile tension compensator with leaf spring			
Electrical warp stop motion	2 contact bars 30 mm pitch	●	-	●
	4 contact bars 16 mm pitch	-	●	●
	Zone detection LHS / RHS	●	-	-

### Pile monitoring

### Cloth take-up

Take-up system	ETU - Electronically controlled Take-Up	●	-	●
Cloth take-up	Diameter of cloth roll: 600 mm	●	-	-
	PBM - Picanol Batching Motion (up to diameter 1,500 mm)	-	●	-
Needle roll	Standard needle density	●	-	●
	High needle density	-	●	●
	Needle roll control	-	●	●
Pile directing plate		-	●	●
Fabric illumination	LED illumination	-	●	●
		above reed	-	●
		above back shed	-	●

### Machine drive and control

Main control	BlueBox electronic platform	●	-	-	
Main motor	SUMO main motor with direct machine drive	●	-	●	
	OptiSpeed (automatic stepless speed variation)	●	-	-	
	Automatic full pickfinding	●	-	-	
Reed motion	Conjugated cams with cam followers	●	-	-	
Shedding motion		●	-	-	
	Positive doobby (R)	-	●	●	
		max 16 harness frames	-	●	●
		max 20 harness frames	-	●	●
	SmartShed (D) digital shedding motion *	16 harness frames	-	●	-
	Execution for electronic jacquard (J)		-	●	●
	AKM - electronic setting of the crossing moment		●	-	-
Harness frame stroke measurement & Shed simulation (SmartShed or doobby)		-	●/package	●/package	
Lubrication	Centralized lubrication, forced circulation of filtered oil to all major drive functions	●	-	-	
Interactive display	15.6" BlueTouch display	●	-	●	
Smart signal lights	Pushbuttons on front panel with integrated signal lights *(design)	●	-	●	
	LED signal torch **	●	-	●	

Standard Optional Aftermarket

**Harness frames**

Driving element	Harness drive DRC30		•	-	-
Harness frames	For 13" heddles	standard (3-point drive)	•	-	•
		extra reinforced (2-point drive)	•	-	•

**Selvedge formation**

Selvedge systems	ELSY - independent electronically controlled selvedge system	LHS / center / RHS	-	•	•
Selvedge cutters	Electronic cutter	LHS / RHS	•	-	•
		center	-	•	•

Temples	Cylinder temples		•	-	•
---------	------------------	--	---	---	---

**Monitoring and software tools**

BlueTouch display	Loom monitoring and reporting		•	-	-
	Browser functionality		•	-	-
	Action center (including Logbook)		•	-	-
	Machine manual + Context based assistance		•	-	-
	Sensor dashboard		•	-	-

PicConnect enabled			•	-	-
--------------------	--	--	---	---	---

Connection provided for major weaving room monitoring systems (parallel communication)			•	-	-
----------------------------------------------------------------------------------------	--	--	---	---	---

Bi-directional communication on ethernet or serial connection			-	•	•
---------------------------------------------------------------	--	--	---	---	---

Climate monitoring			•	-	-
--------------------	--	--	---	---	---

**Safety**

Light curtain	Depending on country of delivery		•	-	•
---------------	----------------------------------	--	---	---	---



ABB0121 - 4 - R 230

**How to read the name**

ABB0121 - 4 - R 230

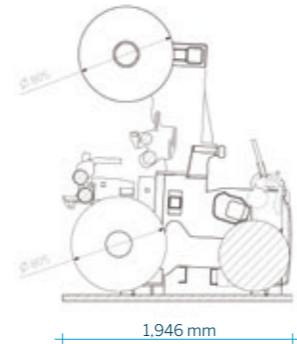
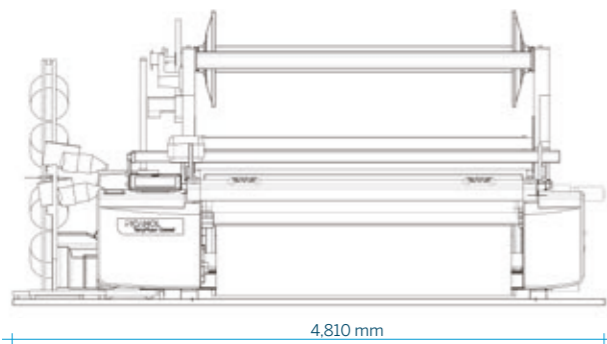
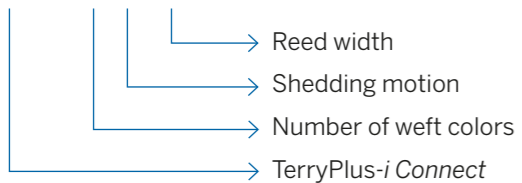

**Regulations**

In designing the TerryPlus-*iConnect*, Picanol has taken into account current international regulations concerning safety (mechanical and electric) and the environment (ergonomics, noise, vibrations, and electromagnetic compatibility).

---

---

---

---

---

---

---

---

---

---

---

---

---

---

---

---

---

---

---

---

---

---

---

---

---

---

# Built in the factory of the future

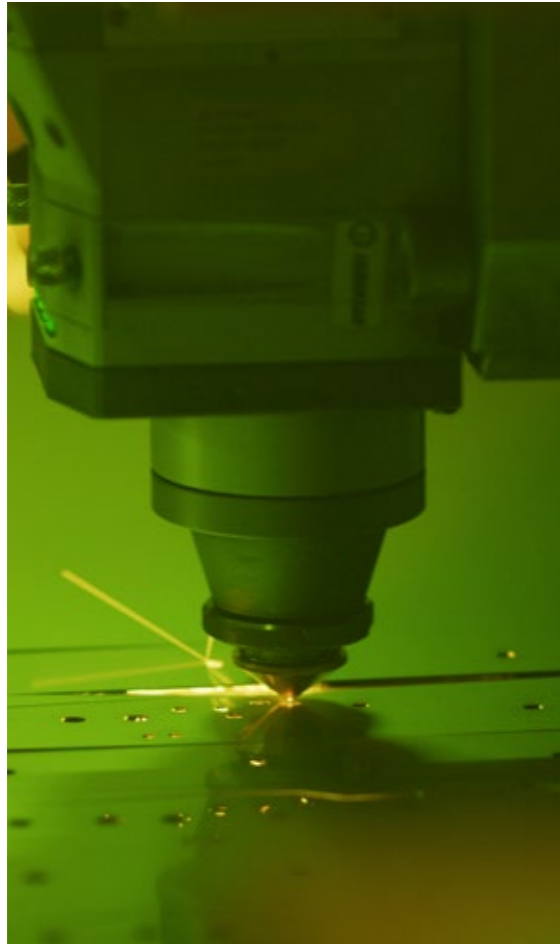

## Training is part of the deal Picanol makes with its customers

Well-trained employees are a real asset to your company. Skilled staff make your machines run at optimum performance, producing excellent fabric quality and resulting in superb plant efficiency.

We feel it is our duty to help your employees to improve their skills and knowledge. Hence, in 2015 we decided to invest in a state-of-the-art Technical Training Center in Ypres.

Three fully equipped rooms (each with weaving machines, cut models, mini workshop etc.) cover a total area of 270 m<sup>2</sup>. This new knowledge center allows Picanol to train technicians from customers around the world in optimal conditions.

All facilities are there to give your employees a warm welcome. If your employees are not able to travel to one of our training centers, our instructors come to you and will organize training at your premises.



## Spare Parts & Weave-Up

Weaving machines are one of your most important investments. Keeping them in optimal condition is essential to safeguard the high value of this asset and to remain competitive as a weaver in a globalizing world.

Use of original Picanol parts guarantees a continued high performance of the Picanol weaving machines.



Moreover, timely replacement of original parts enables Picanol's customers to run their machines in the most economical way.

Regardless of the age of the machine, the use of original parts will keep the machine in top condition which has a positive influence on the value of the machine throughout its life time.

Furthermore, to expand your weaving range and/or increase your machine performance, Picanol offers upgrade packages for installed Picanol machines. Weave-Up upgrades add state-of-the-art technology to your machines, which apart from the benefits in weaving equally increase the value of your investment.



Scan the pictures of the factory with the Picanol app and see the factory come alive.

# Curious about our **upcoming news**?

**Download our new app** on your mobile phone or tablet and thanks to the news notifications feature you will be the first to know about all our innovations. This app is updated frequently so keep an eye out for new arrivals and updates.

You can also subscribe to our **newsletter** at [www.picanol.be/newsletter](http://www.picanol.be/newsletter) to be the first to learn about our latest news, updates and events.

## Book your training course

As already mentioned, training is part of the deal Picanol makes with its customers.

A full list of our training courses can be found on our **website**: [www.picanol.be/training-services](http://www.picanol.be/training-services).

For more information, please contact your local Picanol agent or Customer Service Representative (CSR). See [www.picanol.be/agents](http://www.picanol.be/agents) for contact details.

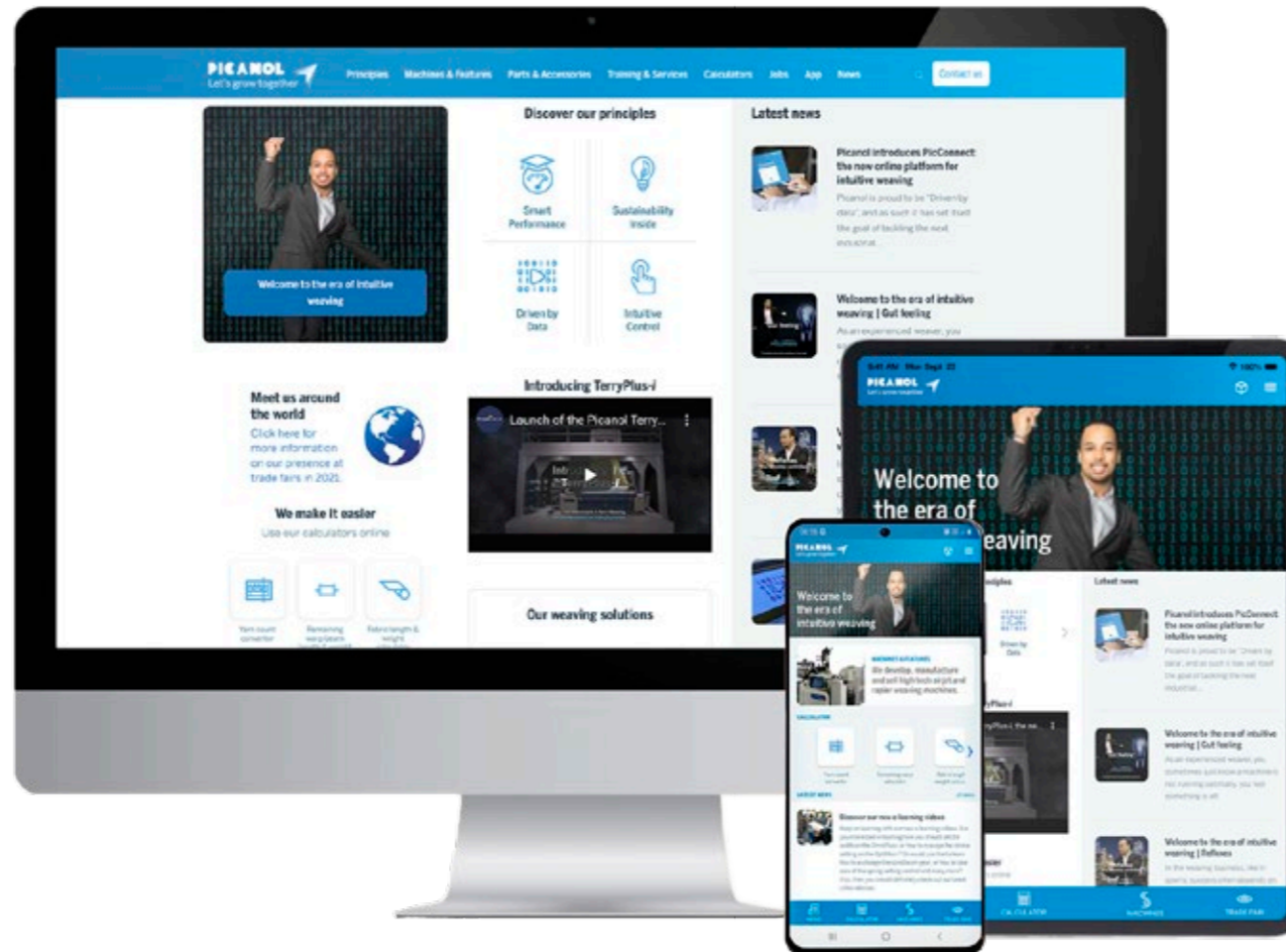

## We make it easier

Our calculators, freshly designed, developed to make weavers' everyday lives easier.

Visit our website [www.picanol.be](http://www.picanol.be) and discover our new integrated weaving calculators online, or **download the app** with the calculators.



## Meet us around the world

During the year, Picanol is present at events and trade fairs around the world. Thanks to the "Trade Fair" function on our app, **you can prepare for your visit**.

With the Picanol app you can discover the machines and the features on show at the main trade fairs, in preparation for your visit. Download the app at [www.picanol.app](http://www.picanol.app).



Download the app at: [www.picanol.app](http://www.picanol.app) or scan this QR code.

# About Picanol



For more than eighty years, Picanol has played a pioneering role in the global textile industry and it is currently the world's leading weaving machine manufacturer. Picanol develops, manufactures, and sells high-tech weaving machines based on airjet and rapier technology. Picanol offers upgrade kits, spare parts, training, troubleshooting services, and also digital services for its weaving machines through the PicConnect platform. Picanol has its headquarters in Ieper (Belgium) and it employs more than 1,200 people worldwide. Picanol is part of Picanol Group, a business unit of Tessenderlo Group (Euronext: TESB).

[www.picanol.be](http://www.picanol.be)



The illustrations and descriptions in this publication do not commit Picanol in any way; specifications may change as a result of developments in engineering and materials. EN 17.09.2024.



Steverlyncklaan 15, 8900 Ieper, Belgium  
+32 57 222 111 - [info@picanol.be](mailto:info@picanol.be)

